

roof drain type 62 H PVC, heated, DN 125

Part number: 623188

GTIN: 4001636623188

Rebate group: 10

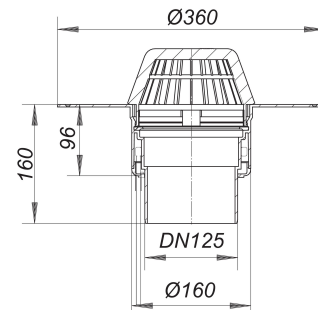

Description:

roof drain type 62 H PVC, heated, DN 125
conforming to DIN EN 1253
one-piece drain, moulded in PVC, PVC membranes can be welded to the flanges

specification:

- insulated drain body
- outlet vertical
- domed grate

material:

PVC

H = roof drain heated version

Connect to 230 V supply, conforming to VDE 0721, Part 1/3.78

Power per drain: 15 watts

Current per drain: 0.06 amps

Suggested current per roof area: 16 amps

Flow rates tested to DIN EN 1253:

Nominal diameter	Outlet direction	Min. flow rate according to norm	Water level according to norm	Flow rate at water level 5 mm	Flow rate at water level 15 mm	Flow rate at water level 25 mm	Flow rate at water level 35 mm	Flow rate at water level 45 mm	Flow rate at water level 55 mm	Flow rate at water level 65 mm	Flow rate at water level 75 mm
DN 125	7.00 l/s	45.00 mm	0.60 l/s	2.50 l/s	4.90 l/s	7.50 l/s	10.75 l/s	14.40 l/s	18.70 l/s	23.10 l/s	
DN 125	7.00 l/s	45.00 mm	1.10 l/s	3.70 l/s	6.00 l/s	8.50 l/s	11.60 l/s	13.90 l/s	14.40 l/s		
DN 125	7.00 l/s	45.00 mm	0.90 l/s	3.80 l/s	6.20 l/s	9.10 l/s	12.10 l/s	15.70 l/s	20.00 l/s		